

Legend Plates – Plastic, Type 4/4X/13 (800H)



Standard Legend Plate
 Cat. No. 800H-W100



Jumbo Legend Plate
 Cat. No. 800H-W100J

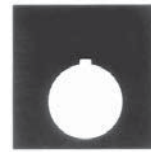

Automotive Legend Plate
 Cat. No. 800H-W100A

Blank/Custom Legend Plates Type 4/4X

Legend Plate Color	Standard	Jumbo	Automotive
	Cat. No.	Cat. No.	Cat. No.
Grey (Blank)	800H-W100	800H-W100J	800H-W100A
Red (Blank)	800H-W300	800H-W300J	800H-W300A
White (Blank)	800H-W500	800H-W500J	800H-W500A
Yellow (Blank)	800H-W700	800H-W700J	800H-W700A
Grey (with Custom Text)	800H-W100E	800H-W100JE	800H-W100AE
Red (with Custom Text)	800H-W300E	800H-W300JE	800H-W300AE
White (with Custom Text)	800H-W500E	800H-W500JE	800H-W500AE
Yellow (with Custom Text)	800H-W700E	800H-W700JE	800H-W700AE

Note: Include text with custom legends.

Custom Text Guidelines

Legend Size	Number of Lines	Maximum Number of Characters per Line
Standard	1 Line of	13
	2 Lines of	13
Jumbo	5 Lines	13
Automotive	4 Lines	16



Potentiometer Legend Plate
 Cat. No. 800H-W080

Potentiometer Legends

Legend Marking	Cat. No.
Graduated Markings Only	800H-W080
SPEED	800H-W081
Custom Legend with Graduated Marking	800H-W080E



Cat. No. 800H-W196



Cat. No. 800H-W797A



Cat. No. 800H-W690

Type	Start/Stop Legend Plates	Emergency Stop Legend Plates	
	Grey Cat. No.	Yellow (Large Size) Cat. No.	Yellow IEC Ring Cat. No.
Push-to-Stop Pull-to-Start	800H-W196	800H-W797A	—
Blank	—	800H-W700A	800H-W690
Custom	800H-W100E	800H-W700AE	—

Standard Legend Plates – Plastic, Type 4/4X/13 (800H)



Grey Legend Plate
 Type 4/4X



White Legend Plate
 Type 4/4X

Marking	Grey Type 4/4X	White Type 4/4X	Marking	Grey Type 4/4X	White Type 4/4X
	Cat. No.	Cat. No.		Cat. No.	Cat. No.
AUTO OFF HAND	800H-W154	800H-W554	LOWER	800H-W115	800H-W515
AUTO MAN OFF	800H-W059	800H-W459	MAN AUTO	800H-W031	800H-W431
CLOSE	800H-W101	800H-W501	MAN OFF AUTO	800H-W062	800H-W462
CYCLE START	800H-W006	800H-W406	MOTOR RUN	800H-W008	800H-W408
CYCLE STOP (Red)	800H-W376	—	MOTOR STOP (Red)	800H-W375	—
DECREASE	800H-W002	800H-W402	OFF	800H-W116	800H-W516
DOWN	800H-W102	800H-W502	OFF COOLANT ON	800H-W052	800H-W452
EMERG. STOP (Red)*	800H-W372	—	OFF LOC REMOTE	800H-W061	—
EMERGENCY STOP (Red)*	800H-W373	—	OFF MAN AUTO	800H-W060	800H-W460
FAST	800H-W104	800H-W504	OFF ON	800H-W133	800H-W533
FEED START	800H-W007	—	ON	800H-W117	800H-W517
FEED STOP (Red)	800H-W377	—	OPEN	800H-W118	800H-W518
FOR. REV.	800H-W132	800H-W532	OPEN CLOSE	800H-W134	800H-W534
FOR. OFF REV.	800H-W152	800H-W552	OPEN OFF CLOSE	800H-W153	800H-W553
FORWARD	800H-W105	800H-W505	OUT	800H-W119	800H-W519
FOURTH SPEED	800H-W010	—	POWER ON	800H-W001	800H-W401
FULL SPEED	800H-W106	800H-W506	PULL-TO-START	800H-W198	—
HAND AUTO	800H-W131	800H-W531	PUSH-TO-STOP (Red)	800H-W378	—
HAND OFF AUTO	800H-W151	800H-W551	RAISE	800H-W120	800H-W520
HIGH	800H-W107	800H-W507	RAISE LOWER	800H-W034	—
HIGH LOW	800H-W030	—	RAISE OFF LOWER	800H-W156	800H-W556
HIGH LOW OFF	800H-W058	—	RESET	800H-W121	800H-W521
HIGH OFF LOW	800H-W155	800H-W555	REVERSE	800H-W122	800H-W522
IN	800H-W108	800H-W508	RIGHT	800H-W005	800H-W405
INCH	800H-W109	800H-W509	RUN	800H-W123	800H-W523
INCREASE	800H-W003	—	RUN INCH	800H-W037	—
JOG	800H-W110	800H-W510	RUN JOG	800H-W032	—
JOG FORWARD	800H-W111	800H-W511	SAFE RUN	800H-W033	—
JOG REVERSE	800H-W112	800H-W512	SECOND SPEED	800H-W124	800H-W524
JOG RUN	800H-W135	800H-W535	SLOW	800H-W125	800H-W525
JOG SAFE RUN	800H-W051	—	SLOW FAST	800H-W136	800H-W536
JOG STOP RUN	800H-W057	—	SLOW OFF FAST	800H-W157	800H-W557
LEFT	800H-W004	800H-W404	SPEED*	800H-W081	800H-W481
LEFT RIGHT	800H-W036	—	SPEED*	800H-W182	—
LOC OFF REMOTE	800H-W055	800H-W455	START	800H-W126	800H-W526
LOW	800H-W113	800H-W513	START JOG	800H-W138	800H-W538
LOW HIGH	800H-W035	—	START JOG STOP	800H-W158	800H-W558
LOW OFF HIGH	800H-W056	—	START RUN STOP	800H-W054	—
LOW SPEED	800H-W114	800H-W514	START STOP	800H-W137	800H-W537

* These legend plates do not comply with E-Stop standards that specify a yellow background, such as IEC 60947-5-5 and NFPA 79.

* Potentiometer type with graduated markings.

Standard Legend Plates – Plastic, Type 4/4X/13 (800H)



Grey Legend Plate
Type 4/4X



White Legend Plate
Type 4/4X

Marking	Grey Type 4/4X	White Type 4/4X	Marking	Grey Type 4/4X	White Type 4/4X
	Cat. No.	Cat. No.		Cat. No.	Cat. No.
UP	800H-W009	800H-W409	STOP (Red)	800H-W371	—
UP DOWN	800H-W039	—	STOP RUN START	800H-W053	—
UP OFF DOWN	800H-W160	800H-W560	STOP START	800H-W038	800H-W438
O (Red)	800H-W184	—	SUMMER OFF WINTER	800H-W159	800H-W559
O I	800H-W185	800H-W582	SUMMER WINTER	800H-W139	800H-W539
I	800H-W181	800H-W581	TEST	800H-W128	800H-W528
I O II	800H-W183	800H-W583	THIRD SPEED	800H-W129	800H-W529

Flip Lever Legend Plates (for use with Series D operators)

Marking	Grey — Type 4/4X	Marking	Grey — Type 4/4X	Marking	Grey — Type 4/4X
	Cat. No.		Cat. No.		Cat. No.
Blank	800H-W200	LOW	800H-W213	RUN	800H-W223
Customer-Specified*	800H-W200E	BAS	800H-W213F	EN MARCHE	800H-W223F
CLOSE	800H-W201	LOW SPEED	800H-W214	SECOND SPEED	800H-W224
FERMER	800H-W201F	VITESSE MIN	800H-W214F	VITESSE 2	800H-W224F
DOWN	800H-W202	LOWER	800H-W215	SLOW	800H-W225
DESCENDRE	800H-W202F	ABAISSER	800H-W215F	LENT	800H-W225F
FAST	800H-W204	OFF	800H-W216	START	800H-W226
RAPIDE	800H-W204F	ARRÊTER	800H-W216F	MARCHE	800H-W226F
FORWARD	800H-W205	ON	800H-W217	TEST	800H-W228
AVANT	800H-W205F	DÉMARRER	800H-W217F	ESSAI	800H-W228F
FULL SPEED	800H-W206	OPEN	800H-W218	THIRD SPEED	800H-W229
VITESSE MAX	800H-W206F	OUVRIER	800H-W218F	VITESSE 3	800H-W229F
HIGH	800H-W207	OUT	800H-W219	I	800H-W281
HAUT	800H-W207F	SORTIR	800H-W219F	O	800H-W284
IN	800H-W208	RAISE	800H-W220	LEFT	800H-W286
ENTRER	800H-W208F	ÉLEVER	800H-W220F	GAUCHE	800H-W286F
INCH	800H-W209	RESET	800H-W221	RIGHT	800H-W287
POUCE	800H-W209F	RÉARMER	800H-W221F	DROITE	800H-W287F
JOG	800H-W210	REVERSE	800H-W222	UP	800H-W288
À COUPS	800H-W210F	ARRIERE	800H-W222F	EN HAUT	800H-W288F

* 12 characters max.

10

Marking	Red — Type 4/4X
	Cat. No.
Blank	800H-W400
Customer-Specified*	800H-W400E
EMERG. STOP	800H-W472
ARRÊT URGENT	800H-W472F
STOP	800H-W471
ARRET	800H-W471F
O	800H-W484

* 12 characters max.

Approximate Dimensions

Dimensions in inches (millimeters). Dimensions are not intended to be used for manufacturing purposes.

Mounting Instructions for Push Buttons with Shallow Blocks, Mini Blocks, Logic Reed Blocks, Sealed Switch Blocks, and Time Delay Blocks (see footnotes for exceptions)

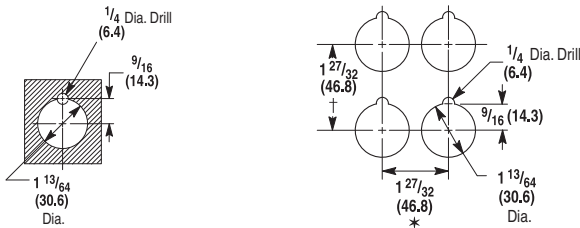

- * Change to 2-1/4 in. (57.2 mm) for transformer type pilot light, push-to-test pilot lights, illuminated selector switches, and all push-pull buttons.
Note: Large legend plate requires minimum horizontal spacing of 2-15/32 in. (62.7 mm).
- ⊛ Vertical minimum spacing dimension changes for the following legend plates: jumbo 2-15/32 in. (62.7 mm); large 2-7/16 in. (61.9 mm); cluster pilot light and 2-, 3-, 4-way switches 2-1/16 in. (52.4 mm).

Sketch illustrates the minimum distance between centerlines when mounting Bulletin 800T/H controls either side-by-side, facing each other, or one above the other. When control units are mounted so that the contact block terminals face each other, the 2-1/4 in. (57.2 mm) dimension must be used in order to get proper electrical clearance. When control units are mounted so that the contact block terminals do not face each other, the 1-27/32 in. (46.8 mm) dimension can be used.

Typical Panel Cut-Out

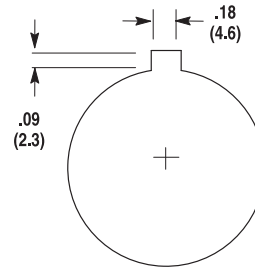

Panel Thickness — Kits are shipped with three 1/16 in. (1.58 mm) gaskets. Refer to table below for number of washers required for various panel thicknesses.

	1/16 in. (1.6 mm) (16 Gauge)	7/64 in. (2.8 mm) (12 Gauge) 9/64 in. (3.6 mm) (10 Gauge)	3/16 in. (4.8 mm) Panel	Thicker Than 3/16 in. (4.8 mm) Panel	Thicker Than 1/4 in. (6.4 mm) Panel
800T	3 washers	2 washers	1 washer	Counterbore to 3/16 in. (4.8 mm)	Counterbore to 3/16 in. (4.8 mm)
800H	4 washers	3 washers	2 washers	1 washer	Counterbore to 1/4 in. (6.4 mm)

Mounting Instructions for 18 mm Small Pilot Lights

Type A Legend Plate

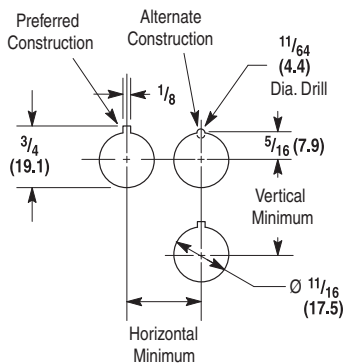

Cat. No. 800T-N515

Type B Legend Plate

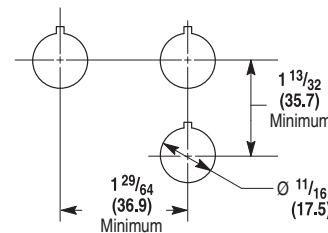

Device	Dimensions	
	Horizontal	Vertical
800T-PS, PSD, PST, QS, QST and RST	31/32 (24.6)	1-5/32 (29.4)
800T-PSDT	1-3/64 (26.6)	1-15/64 (31.4)

30.5 mm Push Buttons

Approximate Dimensions

Dimensions in inches (millimeters). Dimensions are not intended to be used for manufacturing purposes.

Legend Plate Dimensions (Bul. 800T Only)

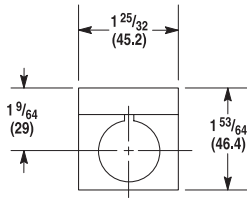

Standard Legend Plate

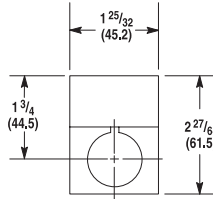

Jumbo Legend Plate

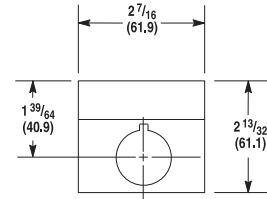

**Large Legend Plate
(Automotive Industry Type)**

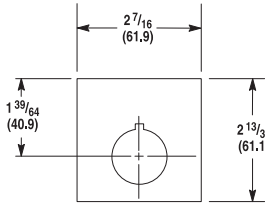

**Large Size
Push-Pull/Twist Legend Plate
Cat. No. 800T-X647***

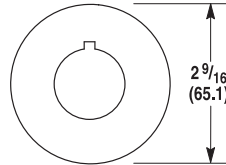

**Round
Cat. No. 800T-X646***

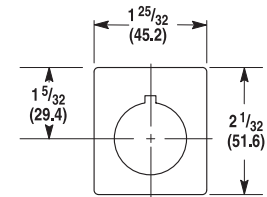

**Cluster Pilot Light and
2-3-4 Way Switch
Silver Legend Plate
Cat. No. 800T-X619**

* For panel mounting only. Not for use with Allen-Bradley enclosures.

Legend Plate Dimensions (Bul. 800H Only)

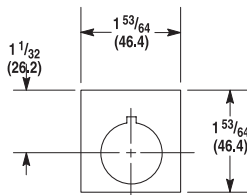

**Type 4/4X
Standard Legend Plate**

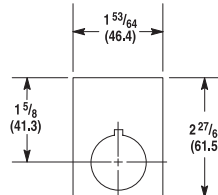

**Type 4/4X
Jumbo Legend Plate**

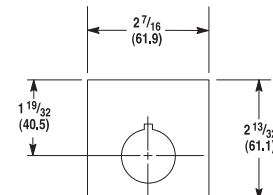

**Type 4/4X
Large Legend Plate
(Automotive Industry Type)**

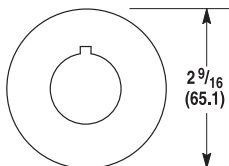

**Type 4/4X
Round**

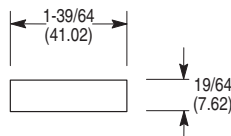

**Type 4/4X
Standard Legend Plate
(Flip Lever Operators)**

Legend Plate Dimensions (Bul. 800T 18 mm Pilot Lights Only)

Legend Plate for Small Pilot Light Type A Legend

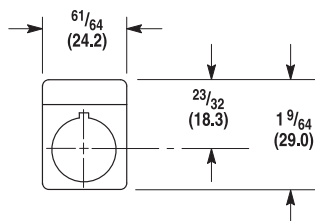

Cat. No. 800T-N515

Legend Plate for Small Pilot Light Type B Legend

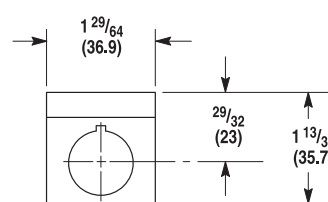

**Cat. No. 800T-N516
(Automotive Industry Type)**